



HINGES WITH DECORATIVE
ALUMINIUM PLUGS

VESTA
HANDLE
AS STANDARD



NEW BOLTWORK
AND BOLTS



Acc. to
EN 15659:2019 (E)
norm

Security level: Class V according to EN 1143-1:2019
Fire rating: Fire-protected safes according to
EN 15659:2019, LFS 30

Suitable for the storage of:

-  office documents, office equipment
-  valuables

Description

Series **save4ever V** - safes with ECB•S certificate for storage of valuables.

Double protective mechanism: additional glass plate, which triggers bolting protection against the burglary attempt.

Body: multi-walled body

Door: multi-walled door construction

Locking: 4-way locking bolt system - incl. overlapping profile on the hinge side

Standard option

Lock: 2 high security key locks II class VdS II/IMP - class B (each lock with 2 keys)

Boltwork handle: handle protruding 79 mm

Hinges: External

Door opening angle: 180°

Mounting holes: 1 hole in the bottom, 1 blind hole in the back wall up to 1/3 height (assembly set for 1 hole as standard)

Additional equipment: each model prepared for alarm installation

Paint: RAL 7024, RAL 7035

save4ever V





key lock



427100.11 / 427100.01



427101.11 / 427101.01



427102.11 / 427102.01



427103.11 / 427103.01



427104.11 / 427104.01

Outer dimensions HxWxD (mm)	660 x 536 x 525	660 x 606 x 525	756 x 606 x 525	906 x 606 x 525	1106 x 606 x 525
Inner dimensions HxWxD (mm)	504 x 370 x 305	504 x 440 x 305	600 x 440 x 305	750 x 440 x 305	950 x 440 x 305
Weight	373 kg	406 kg	455 kg	531 kg	633 kg
Files number (pcs.):	6	6	8	10	13
Shelves number (pcs.):	1	1	1	1	2
Hooks on the hook bar (pcs.) *	5	5	5	5	5
Volume (l.)	57	68	81	101	127
Lock type	Double key locks (each with 2 keys)				
Paint	RAL 7024 / RAL 7035				

* hook strip for self assembly



key lock



427105.11 / 427105.01



427106.11 / 427106.01



427107.11 / 427107.01



427108.11 / 427108.01



427109.11 / 427109.01

Outer dimensions HxWxD (mm)	1256 x 606 x 525	1406 x 606 x 525	806 x 736 x 565	1256 x 736 x 565	1506 x 736 x 565
Inner dimensions HxWxD (mm)	1100 x 440 x 305	1250 x 440 x 305	650 x 570 x 345	1100 x 570 x 345	1350 x 570 x 345
Weight	709 kg	785 kg	580 kg	846 kg	994 kg
Files number (pcs.):	15	17	11	21	25
Shelves number (pcs.):	2	3	1	2	3
Hooks on the hook bar (pcs.) *	5	5	5	5	5
Volume (l.)	127	168	128	216	265
Lock type	Double key locks (each with 2 keys)				
Paint	RAL 7024 / RAL 7035				

* hook strip for self assembly



key lock



427110.11 / 427110.01



427111.11 / 427111.01



427112.11 / 427112.01



427113.11 / 427113.01



427114.11 / 427114.01

Outer dimensions HxWxD (mm)	1512 x 842 x 565	1812 x 842 x 565	1262 x 872 x 715	1512 x 872 x 715	1812 x 872 x 715
Inner dimensions HxWxD (mm)	1356 x 676 x 345	1656 x 676 x 345	1106 x 706 x 495	1356 x 706 x 495	1656 x 706 x 495
Weight	1093 kg	1285 kg	1108 kg	1294,4 kg	1516 kg
Files number (pcs.):	35	42	27	35	42
Shelves number (pcs.):	3	4	2	3	4
Hooks on the hook bar (pcs.) *	5	5	5	5	5
Volume (l.)	316	386	387	474	579
Lock type	Double key locks (each with 2 keys)				
Paint	RAL 7024 / RAL 7035				

* hook strip for self assembly

** available options of changing the lock

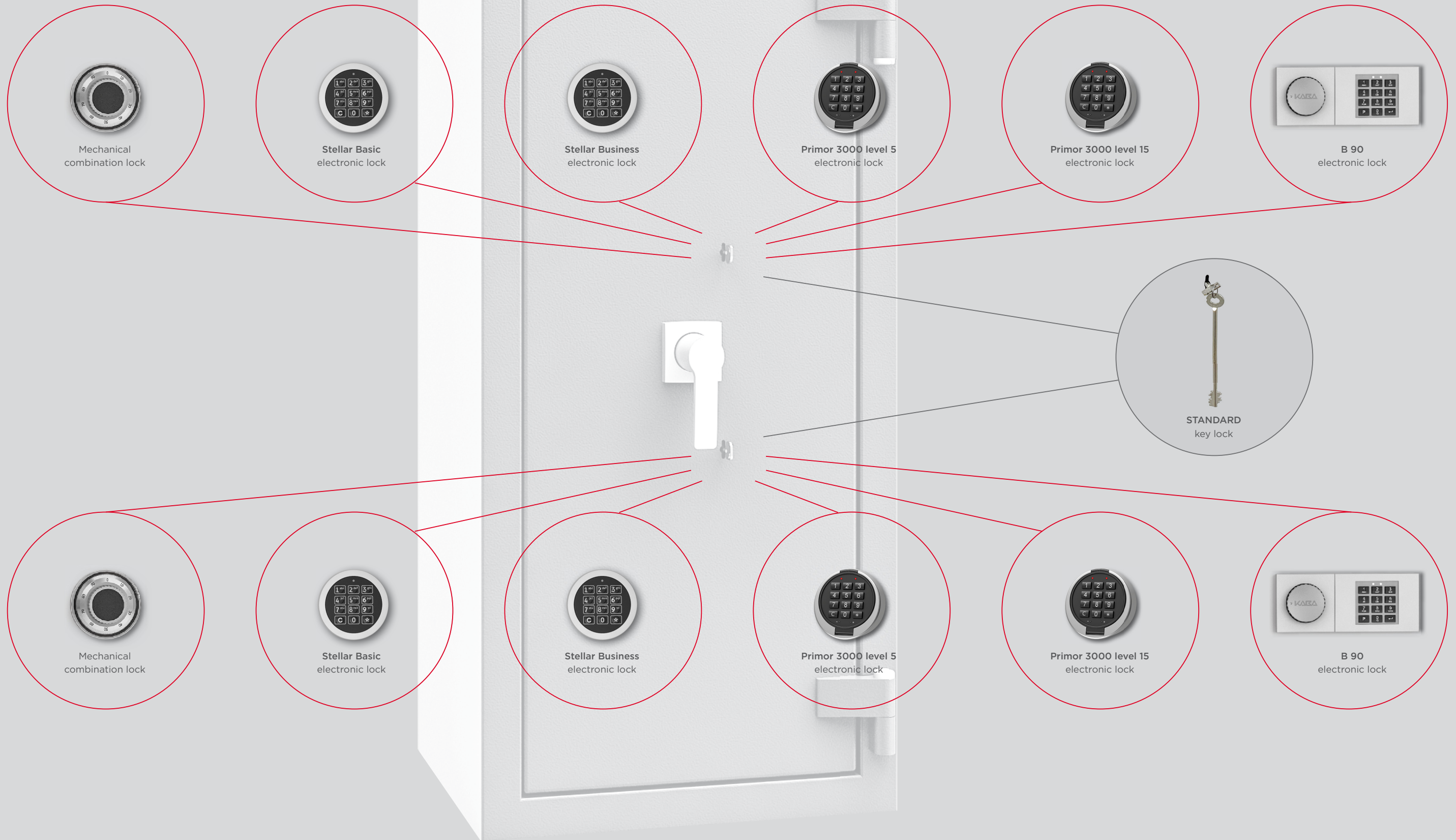

Possible lock configurations



Mechanical combination lock

Key lock



Stellar Basic - electronic lock

Key lock



Stellar Business - electronic lock

Key lock

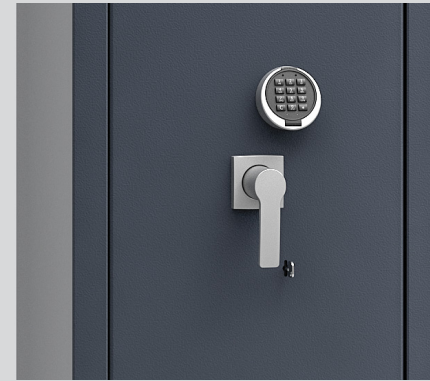

Primor 3000 level 5 - electronic lock

Key lock



Primor 3000 level 15 - electronic lock

Key lock



B 90 - electronic lock

Key lock

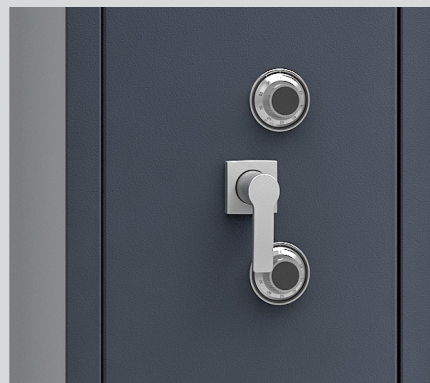

Mechanical combination lock

Mechanical combination lock

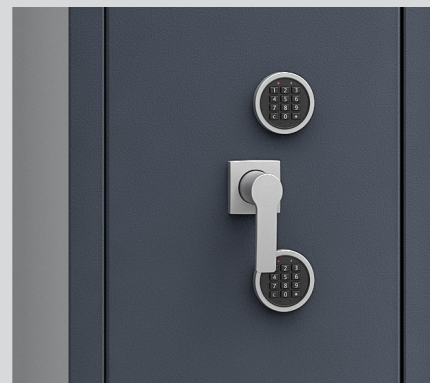

Stellar Basic - electronic lock

Stellar Basic - electronic lock

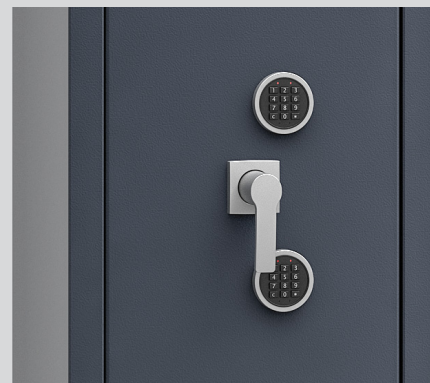

Stellar Business - electronic lock

Stellar Business - electronic lock

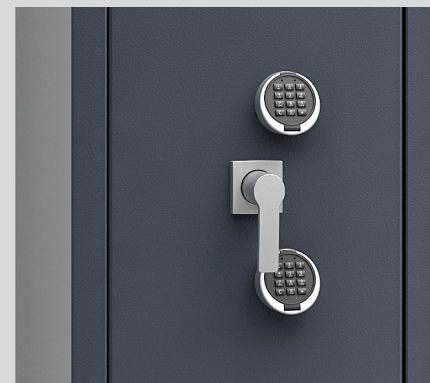

Primor 3000 level 5 - electronic lock

Primor 3000 level 5 - electronic lock

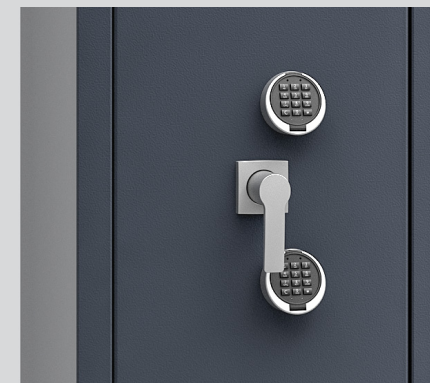

Primor 3000 level 15 - electronic lock

Primor 3000 level 15 - electronic lock

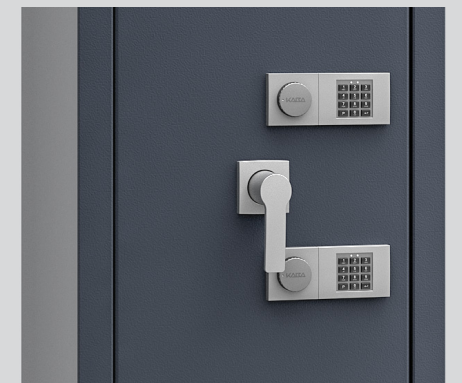

B 90 - electronic lock

B 90 - electronic lock



Preparation for alarm system

save4ever V series has standard holes that enable the installation of alarm system components.



Alarm system (EMA)

- complete set (also available in single positions).

When installing the alarm system or single components, the safe is equipped with the bottom cover, which diminishes the safe space inside by 30 mm.

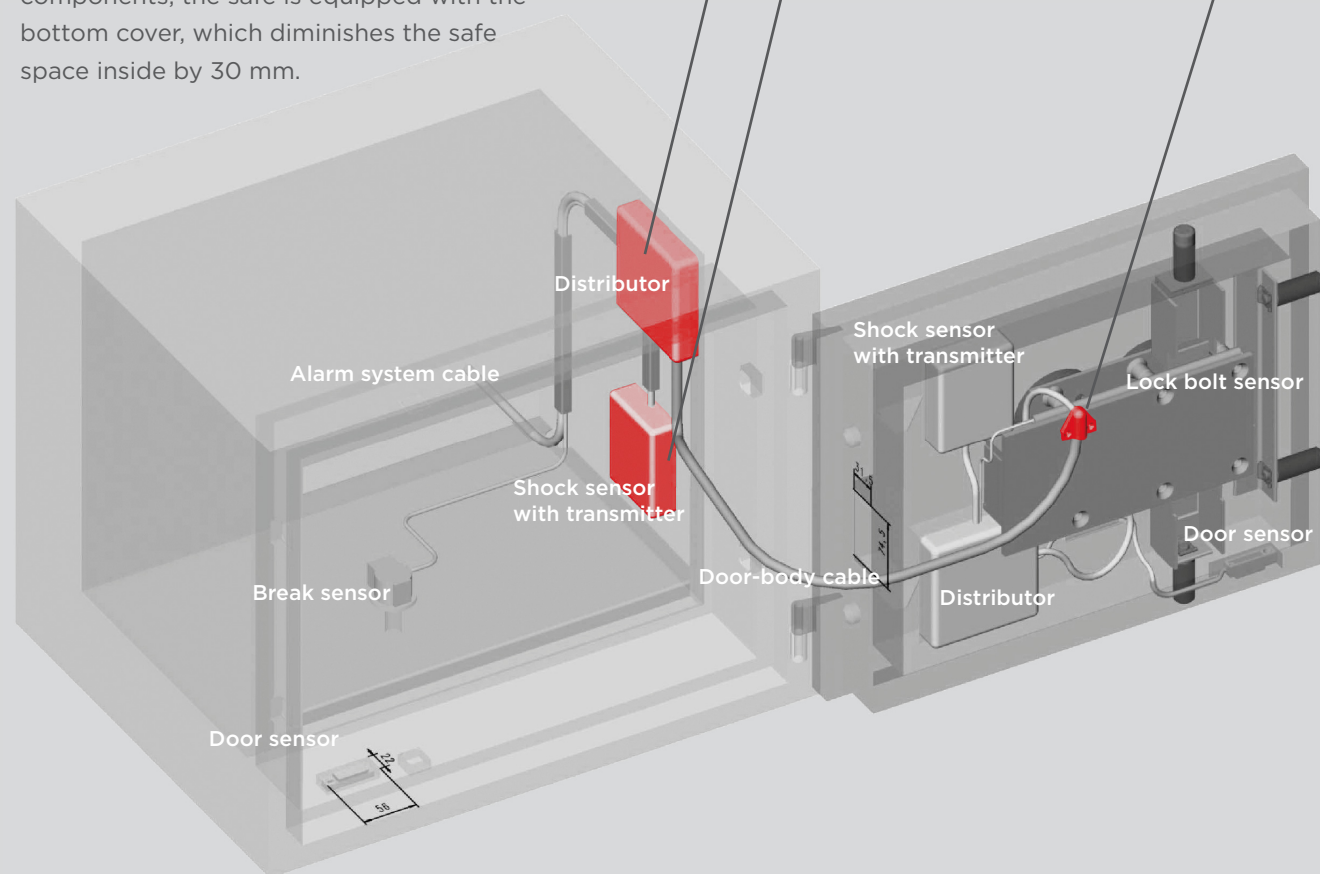

Fire resistance of class V safes

The real and functional fire resistance of safes is one that is confirmed by **certificates and appropriate tests**.

Fire resistance is the ability of safes to meet certain requirements during a fire.

The measure of the fire resistance of safes is the time expressed in minutes, in a simplified way illustrating how long a given safe can protect its contents from extremely severe conditions during a fire and fire action.

The light fire resistance defined by the LFS 30 class provides the stored property with short-term fire protection of 30 minutes.

Norm EN 15659:2019 implies heating the safe together with furnace according to temperature curve up to 840°C, and measuring the temperature in critical parts of the safe inside when it is heated up.

Certification label permanently fixed to the safe is a **guarantee for properly conducted test in specialized certification institutes**.



Acc. to
EN 15659:2019 (E)
norm



Fire seal

Foam seal